

COBRA



GLASS SHELF
SUPPORTS



SYMBOLS AND FINISHES LEGEND

SYMBOLS



= SHELF SAFELY LOCKED DURING TRANSPORTATION AND AT HOME.



= ANTI-TURNOVER LOCKING SYSTEM



= NORMS / PATENTS



= PHILLIPS / POZIDRIV



= NEWTON



= PART.NO



= HEXAGONAL SOCKET



= FRICTION



= PCS. PER PACKAGE



= BLADE SLOT



= AUTOMATIC



= COMBI SLOT



= DROP DOWN



= CAPACITY LOADING



= COUNTERSUNK HEAD



= WOOD / GLASS THICKNESS



= PAN HEAD



= STANDARD HINGE



= HOLE DIAMETER



= FLANGE HEAD



= KIMANA HINGE



= DIAMETER



= FLAT HEAD



= FLAP HINGE



= LENGTH



= TRILOBULAR SCREW



= WITH SPRING



= HEIGHT



= SELF-TAPPING SCREW



= WITHOUT SPRING



= RIGHT VERSION



= EURO THREAD



= REVERSED SPRING



= LEFT VERSION



= METRIC THREAD



= SETTING CODE



= PRE-INSERTED SCREW



= FOR ROUND TUBE



= PCS. PER PAD



= PRE-INSERTED SCREW AND SPREADING BUSH



= FOR OVAL TUBE



= CUT ON REQUEST



= WITH BUFFER



= SELF ADHESIVE



= WITH MAGNET



= WITH FLANGE

NOTE: Printing errors and omissions may exist despite our best efforts to ensure accuracy. We reserve the right to alter specifications without notice.

MATERIALS

ZA = Zinc Alloy	ST = Steel	HSS = High Speed Steel	BR = Brass	ABS = Acrylonitrile Butadiene Styrene
ZAnk = Nickel-plated Zinc Alloy	STzk = Zinc-plated Steel	AL = Aluminium	WD = Wood	EVA = Ethylene Vinyl Acetate

EP = **ENGINEERING PLASTIC**

+ **EP** = other engineering plastic available on request

SR = **SOFT RUBBER**

+ **SR** = other soft rubber available on request

EPn = Natural Engineering Plastic	EPc = Clear Engineering Plastic	SRn = Natural Soft Rubber
EPw = White Engineering Plastic	EPg = Grey Engineering Plastic	SRw = White Soft Rubber
EPwg = Water Green Engineering Plastic		SRb = Black Soft Rubber



FINISHES



= OTHER FINISHES AVAILABLE ON REQUEST

AA	Natural	JB	Bright Aluminium	QB	Walnut
AB	White	JC	Aluminium - Chrome	RO	Red
AC	Opal White	JD	Matt Aluminium	UZ	T -Met
AE	White 9010	JE	Satin-finished Aluminium	WA	Bronzed
AK	Champagne	JF	Aluminium - Brass	WI	Burnished
AL	Ivory	JG	Aluminium 5	XD	Satin-finished Steel
EA	Black	JL	Aluminium PE 11	YA	Nickel-plated
EB	Glossy Black	JM	Aluminium RAL 9006	YB	Bright Nickel-plated
EC	Matt Black	KA	Chrome	YC	Matt Nickel-plated
EE	Anthracite	KB	Bright Chrome	YD	Satin-finished Nickel-plated
FU	Gunmetal	KC	Matt Chrome	ZA	Zinc alloy
GR	Raw	MA	Brown	ZN	Zinc-plated
HA	Brass-Plated	MB	Light Brown 1	ZQ	Bright Gold
HH	Tropicalized	NN	Metallic Beige	ZY	Titanium
HL	Raw Brass	NO	Beige	ZZ	Clear
IA	Grey	OA	Oak	00	Insignificant finish
IB	Metallic Grey	OZ	Ash		
IF	Middle Grey	PA	Light Ash		
IJ	Light Grey	PZ	Beech		
IL	Grey 20	QA	Maple		

COBRA

Glass shelf support.

In accordance with the regulation UNI EN 14749/05.

Zinc alloy
Engineering plastic



5 - 10 mm

UNI EN 14749/05.

INSTALLATION

Assembling with smooth pin

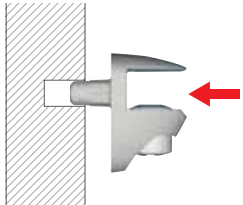

Assembling with alternative fixing options
to achieve horizontal connection

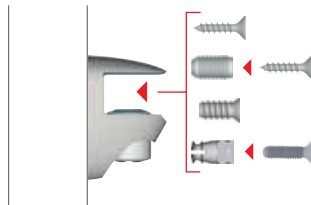

Metric insert in engineering plastic
cross PZ2 screwdriver

SHELF INSTALLATION

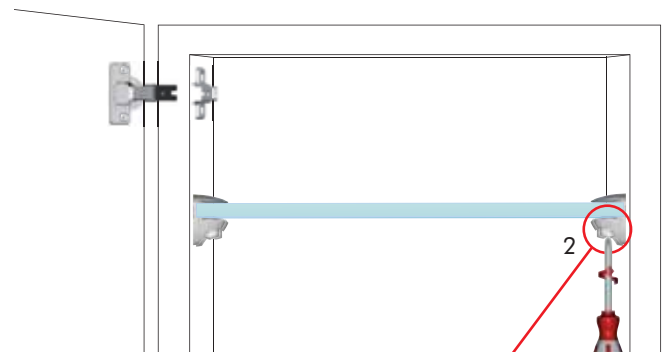
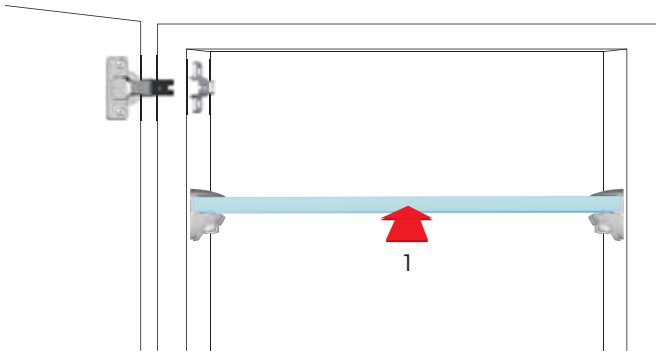

SHELF REMOVAL FOR NEW REPOSITIONING

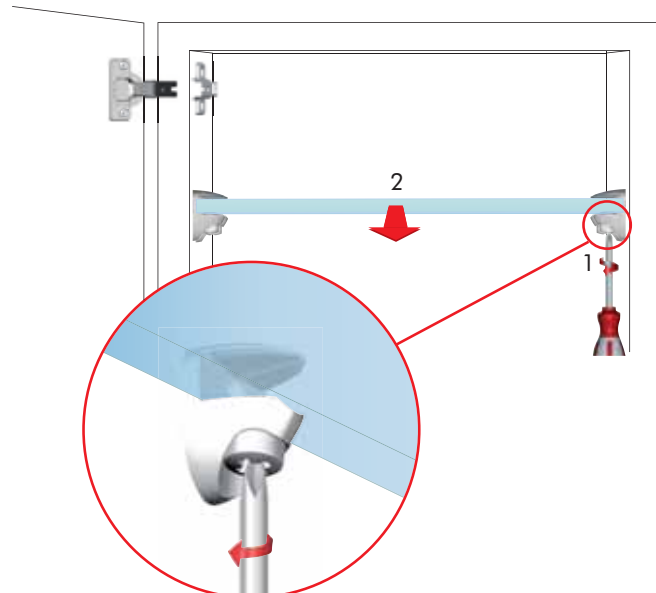

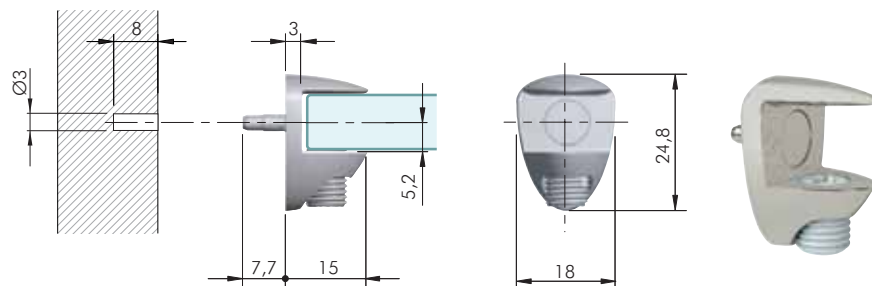
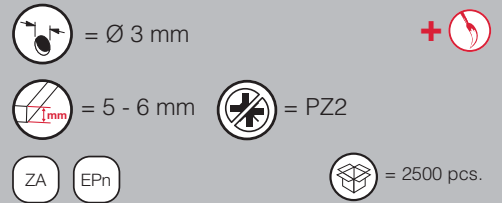
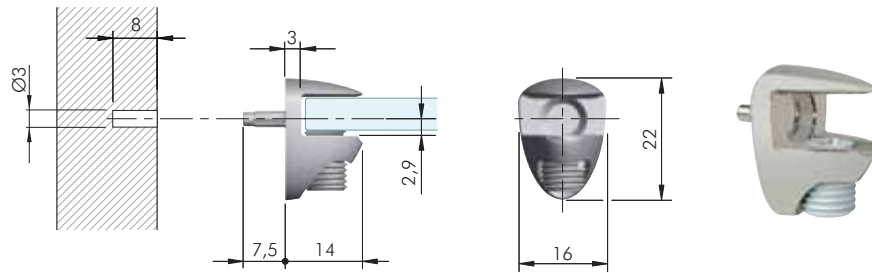
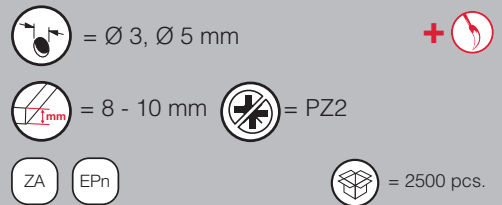
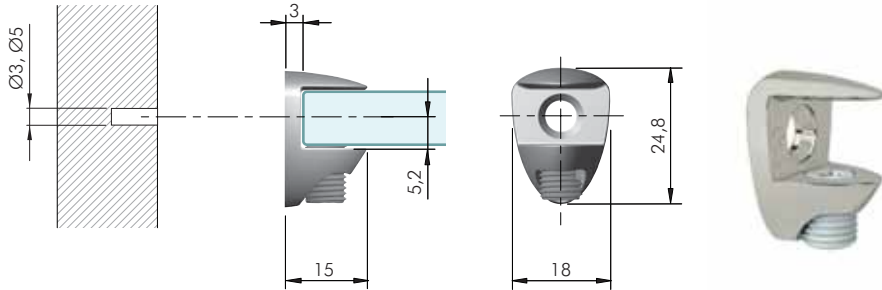
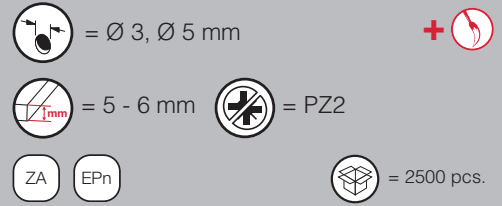
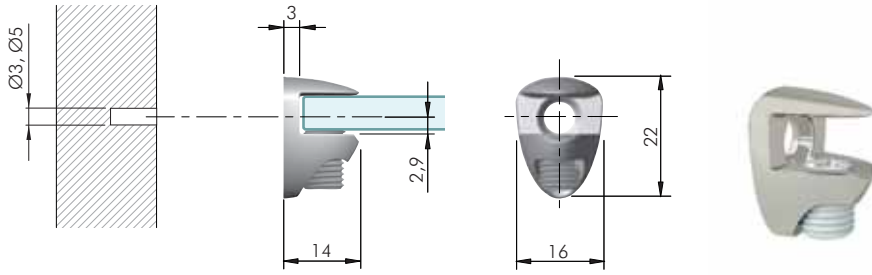

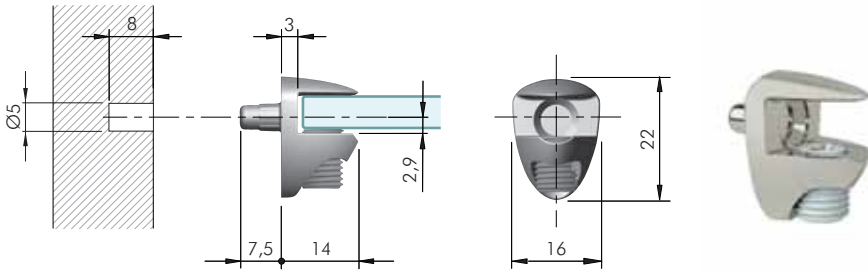

= Ø 5 mm +
 = 5 - 6 mm = PZ2
 ZA EPn = 2500 pcs.

16014030YA

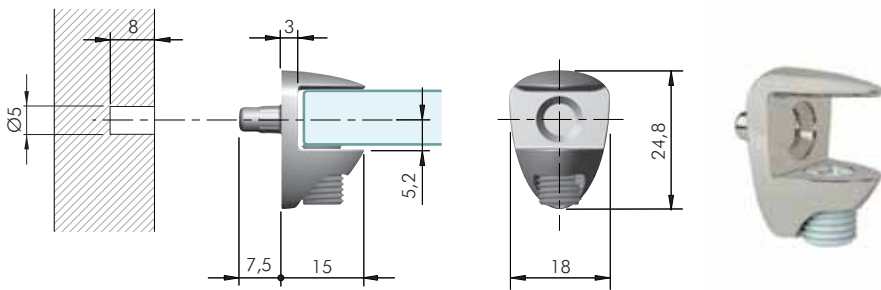

= Ø 5 mm +
 = 8 - 10 mm = PZ2
 ZA EPn = 2500 pcs.

16014040YA

COBRA FIXING ACCESSORIES

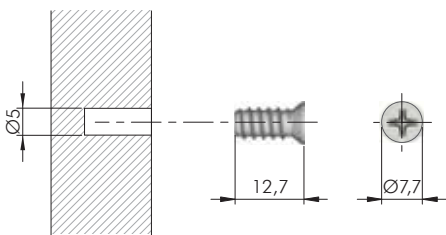

= Ø 5 mm +
 = PZ2
 ST = 5000 pcs.



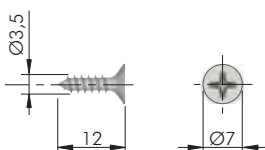

60501050YA

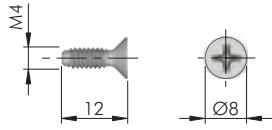

= Ø 3 mm
 = PZ2
 ST = 10.000 pcs.

60101380ZN





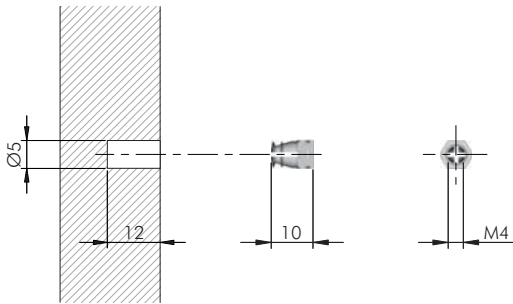

 = M4
  = PZ2
 ST
  = 2000 pcs.

 123

 60305040ZN







 = Ø 5 mm
  = M4
 BR
  = 20.000 pcs.

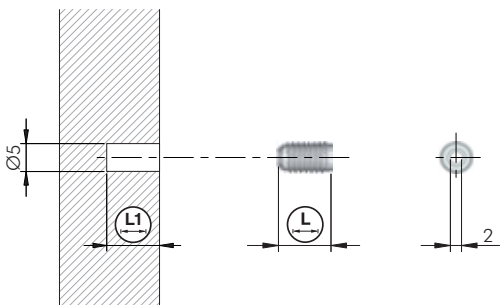

 123

 20502021HL



 = Ø 5 mm
 EPn
  = 5000 pcs.

 123

 20302020AA

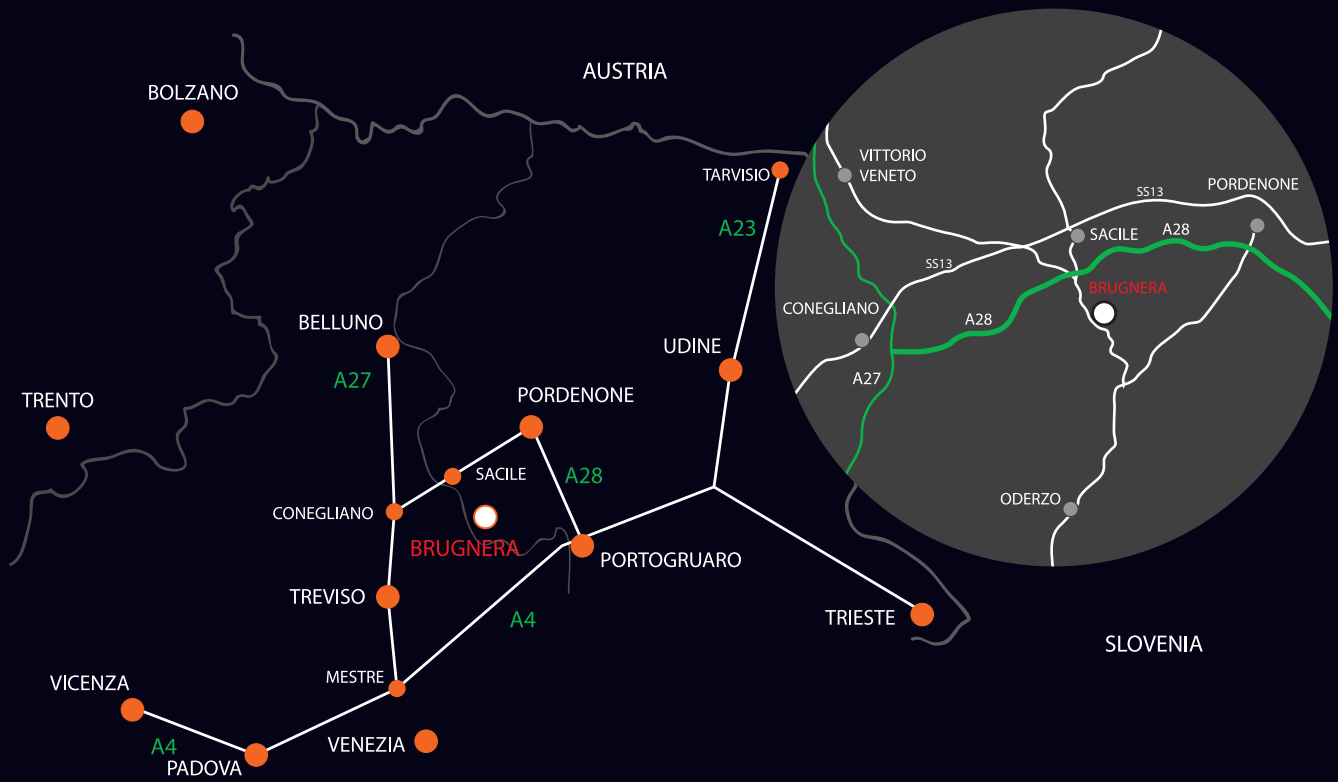
	
9,5	11,5



www.italianaferramenta.com